



# TSW100



# HARDWARE

## FRONT VIEW

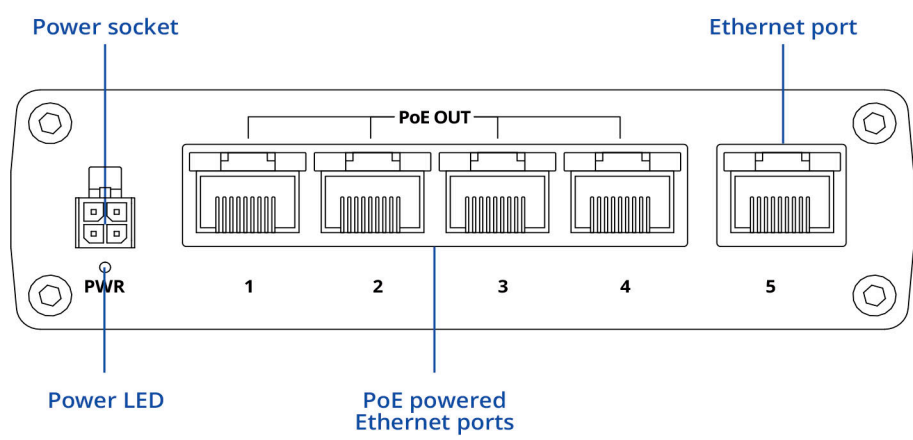

## BACK VIEW

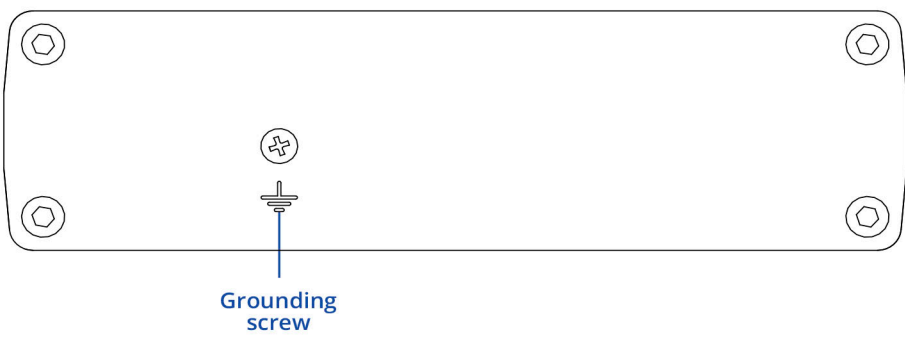

## RJ45 LED MEANING

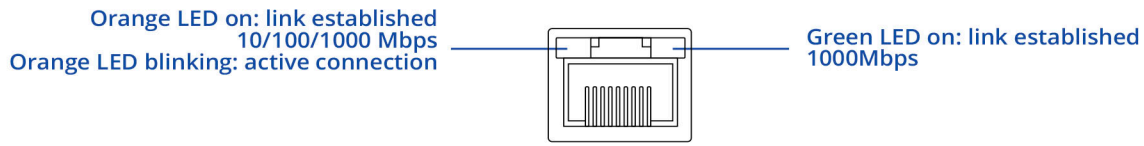

## POWER SOCKET PINOUT

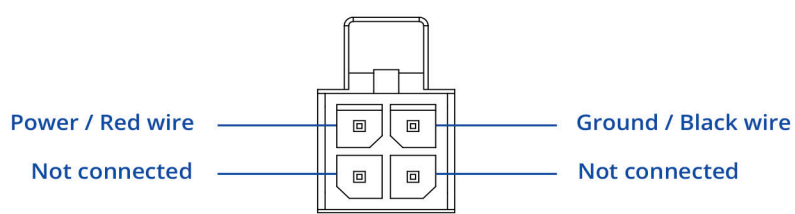

# FEATURES

## ETHERNET

LAN	5 x LAN ports, 10/100/1000 Mbps, compliance with IEEE 802.3, IEEE 802.3u, 802.3az standards, supports auto MDI/MDIX crossover
-----	---

## POE

PoE ports	Port 1- 4
PoE standards	802.3af and 802.3at
PoE Max Power per Port (at PSE)	30 W
Total PoE Power Budget (at PSE)	120 W

## PERFORMANCE SPECIFICATIONS

Bandwidth (Non-blocking)	10 Gbps
Packet buffer	128 KB
MAC address table size	2K entries

## POWER

Connector	4 pin industrial DC power socket
Input voltage range	7-57 VDC
Input voltage range for PoE	44-57 VDC
Power consumption (idle/max no PoE/max)	2 W/9 W/129 W

## PHYSICAL INTERFACES (PORTS, LEDS)

Ethernet	5 x RJ45 ports, 10/100/1000 Mbps
Status LED's	1 x Power LED, 10 x LAN status LED's
Power	1 x 4 pin DC connector
Ground	1 x Grounding screw

## PHYSICAL SPECIFICATION

Casing material	Full aluminum housing
Dimensions (W x H x D)	115 x 32 x 95 mm
Mounting	DIN rail or wall mounting (additional kit needed), flat surface placement

## OPERATING ENVIRONMENT

Operating temperature	-40 °C to +75 °C
Operating humidity	10 % to 90 % non condensing

# HARDWARE INSTALLATION

1. Connect your main internet router/modem to TSW100 LAN port number 5.
2. Connect end devices (ex. IP camera) to TSW100 1 to 4 port, which you want to power via Ethernet.
3. Connect 4 pin power plug to TSW100 to power up switch.

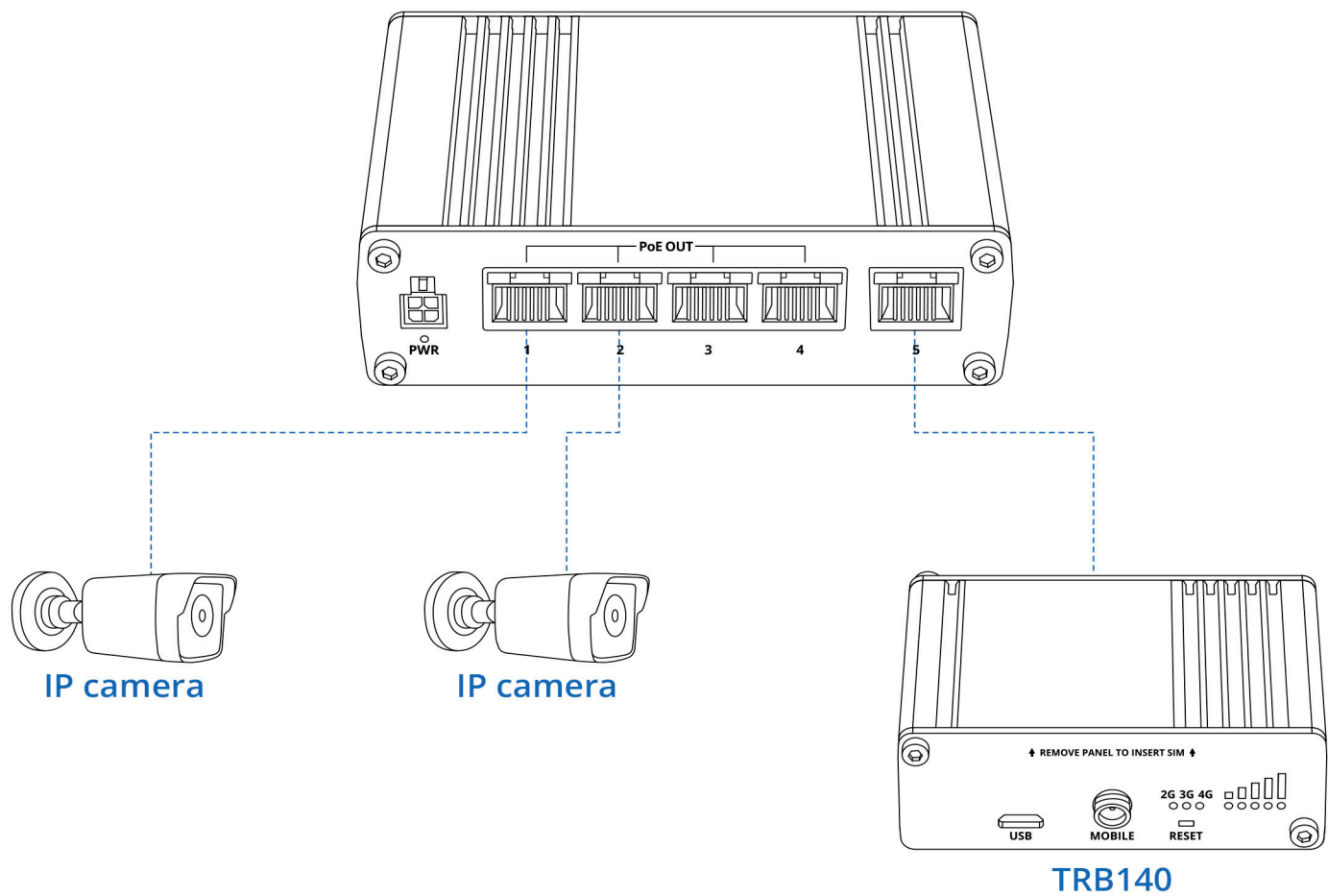

## TECHNICAL INFORMATION

Technical specifications	
Input voltage range*	7 – 57 VDC
Max power consumption no PoE devices connected	<9 W
Max PoE power budget at PSE**	120 W
Max Ethernet cable length	100 m
Bundled accessories specifications*	
Power adapter	Input: 1.8 A @100-240 VAC, Output: 48 VDC, 1.3 A, 4 pin plug

\* PoE operates properly only when connected power supply outputs 44 V or higher voltage.  
 \*\* Provided power supply only allows 60 W PoE power budget at PSE, to reach maximum 120 W at PSE >130 W power supply must be used  
 \*\*\* Order code dependent.

# WHAT'S IN THE BOX?

## STANDARD PACKAGE CONTAINS\*

- TSW100
- 62 W PSU
- QSG (Quick Start Guide)
- Packaging box

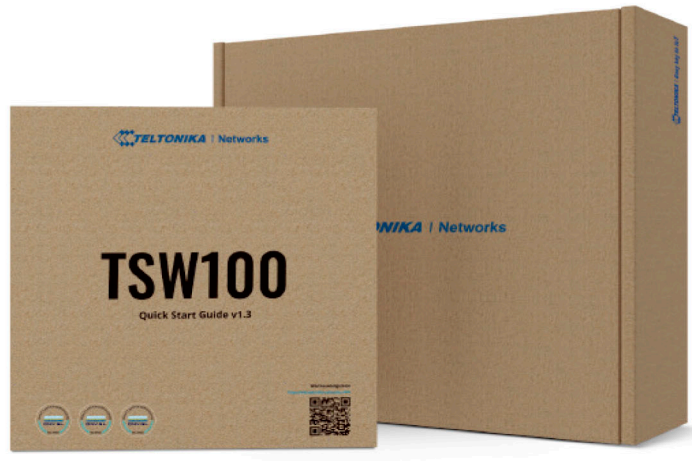

\* For all standard order codes standard package contents are the same, except for PSU.

## STANDARD ORDER CODES

PRODUCT CODE	HS CODE	HTS CODE	PACKAGE CONTAINS
TSW100000000	851762	8517.62.00	Standard package with Euro PSU
TSW100000010	851762	8517.62.00	Standard package with US PSU
TSW100000020	851762	8517.62.00	Standard package with AU PSU

For more information on all available packaging options – please contact us directly.

## MOUNTING OPTIONS

### DIN RAIL KIT

Parameter	Value
Mounting standard	35mm DIN Rail
Material	Low carbon steel
Weight	57g
Screws included	Philips Pan Head screw #6-32×3/16, 2pcs
Dimensions	82 mm x 46 mm x 20 mm
RoHS Compliant	V

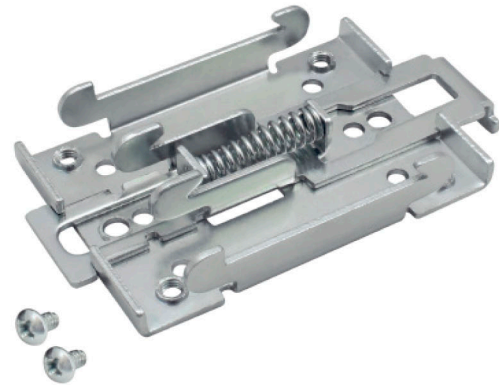

### DIN RAIL KIT

- DIN Rail adapter
- Philips Pan Head screw #6-32×3/16, 2pcs for RUT2xx/RUT9xx

### ORDER CODE

ORDER CODE	HS CODE	HTS CODE
PR5MEC00	73269098	7326.90.98

For more information on all available packaging options – please contact us directly.

### COMPACT DIN RAIL KIT

Parameter	Value
Mounting standard	35mm DIN Rail
Material	ABS + PC plastic
Weight	6.5 g
Screws included	Philips Pan Head screw #6-32×3/16, 2pcs
Dimensions	70 mm x 25 mm x 14,5 mm
RoHS Compliant	V



### DIN RAIL KIT

- Compact plastic DIN Rail adapter (70x25x14,5mm)
- Philips Pan Head screw #6-32×3/16, 2pcs

### ORDER CODE

ORDER CODE	HS CODE	HTS CODE
PR5MEC11	73269098	7326.90.98

For more information on all available packaging options – please contact us directly.

### SURFACE MOUNTING KIT

Parameter	Value
Mounting standard	Flat surface mount
Material	ABS + PC plastic
Weight	2x5 g
Screws included	Philips Pan Head screw #6-32×3/16, 2pcs
Dimensions	25 mm x 48 mm x 7.5 mm
RoHS Compliant	V



### DIN RAIL KIT

- Surface mounting kit
- Philips Pan Head screw #6-32×3/16, 2pcs

### ORDER CODE

ORDER CODE	HS CODE	HTS CODE
PR5MEC12	73269098	7326.90.98

For more information on all available packaging options – please contact us directly.

# TSW100 SPATIAL MEASUREMENTS & WEIGHT

## MAIN MEASUREMENTS

W x H x D dimensions for TSW100:

Device housing*:	115 x 32 x 95
Box:	173 x 71 x 148

\*Housing measurements are presented without antenna connectors and screws; for measurements of other device elements look to the sections below.

## TOP VIEW

The figure below depicts the measurements of TSW100 and its components as seen from the top:

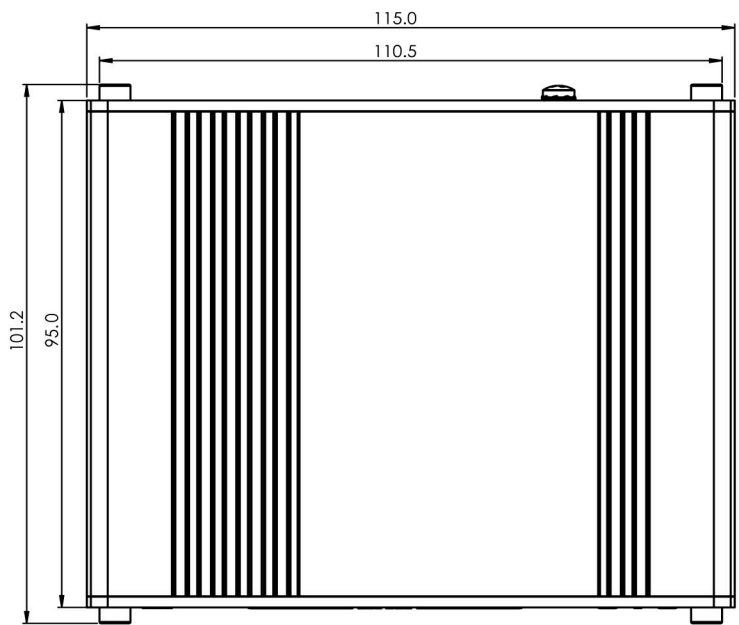

## RIGHT VIEW

The figure below depicts the measurements of TSW100 and its components as seen from the right side:

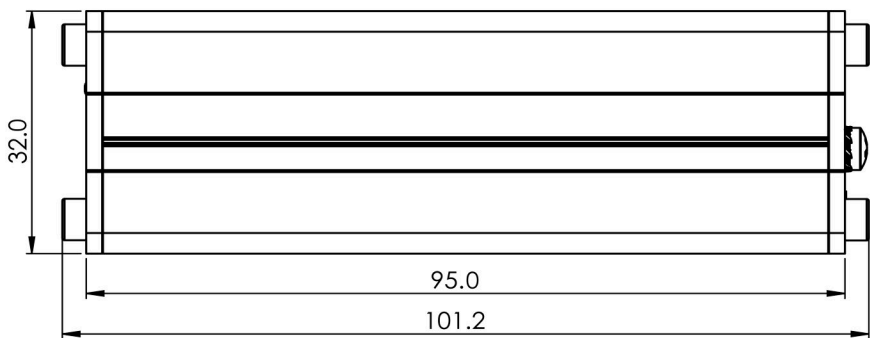



FRONT VIEW

The figure below depicts the measurements of TSW100 and its components as seen from the front panel side:

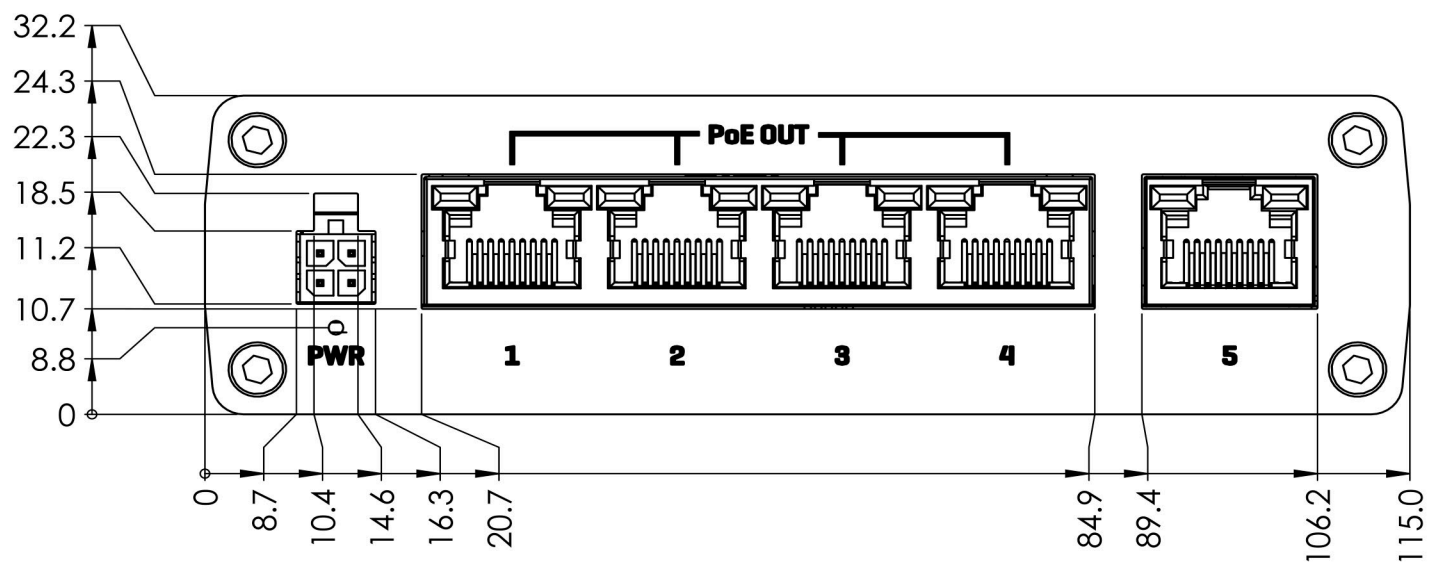

REAR VIEW

The figure below depicts the measurements of TSW100 and its components as seen from the back panel side:

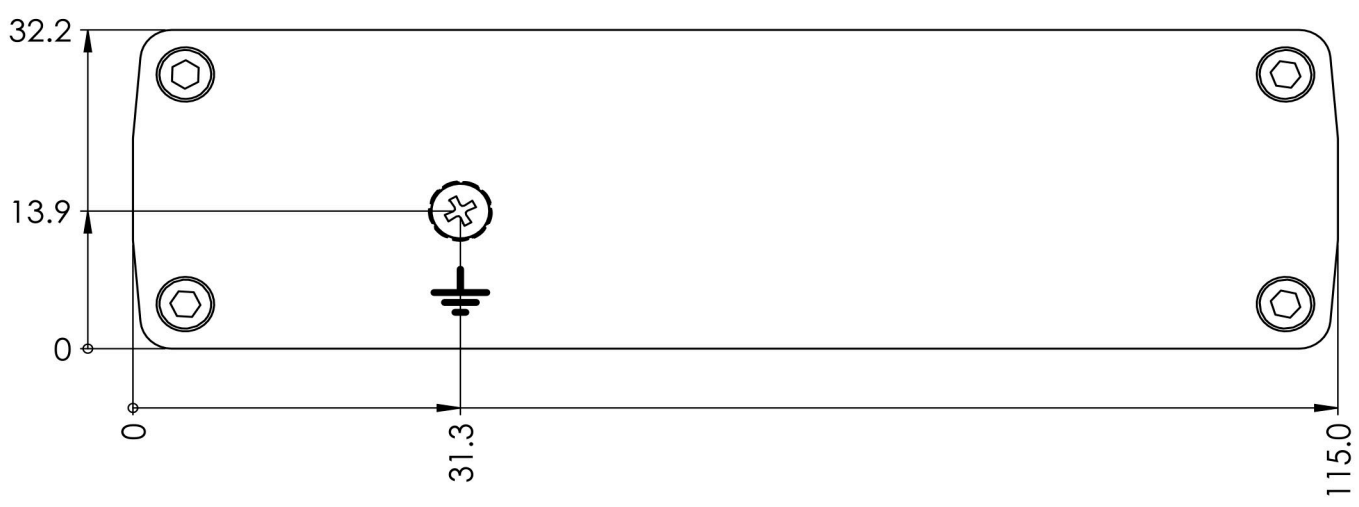

**MOUNTING SPACE REQUIREMENTS**

The figure below depicts an approximation of the device's dimensions when cables and antennas are attached:

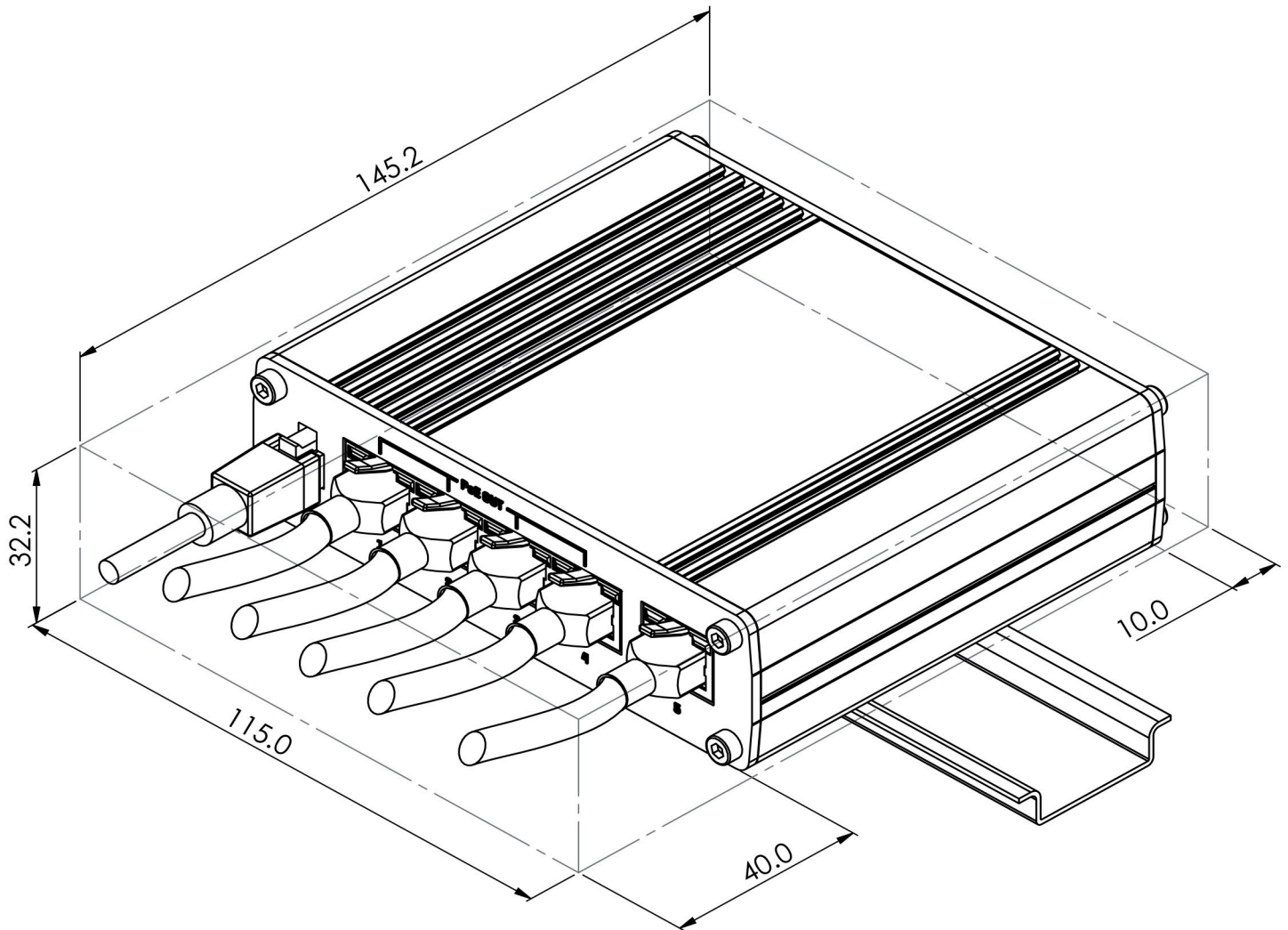

DIN RAIL

The scheme below depicts protrusion measurements of an attached DIN Rail:

